

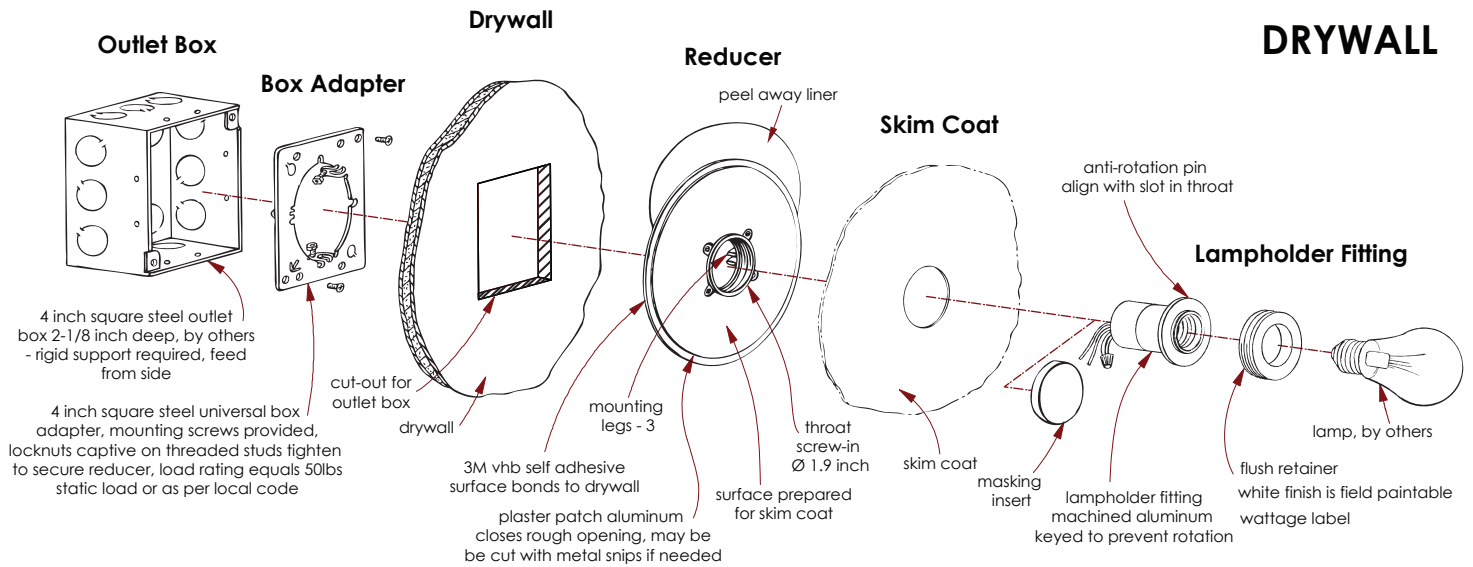

RECESSED SOCKETS
Medium Base Lampholder

DRYWALL



UL LISTED - PATENT NO.

MILLWORK

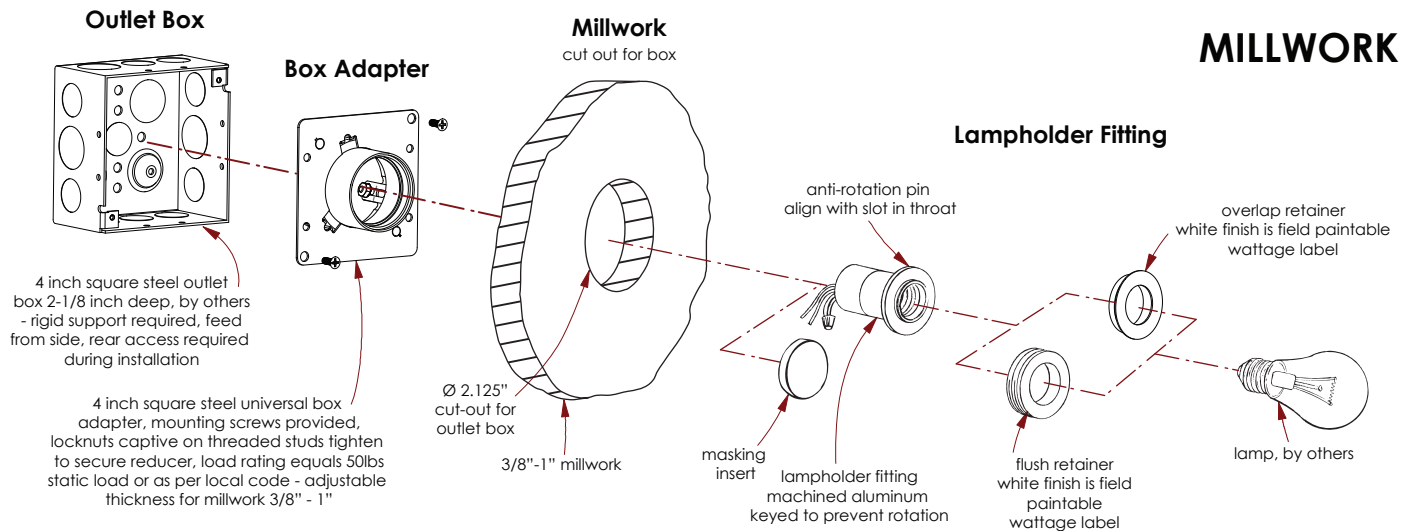

UL LISTED - PATENT NO.

MIRROR

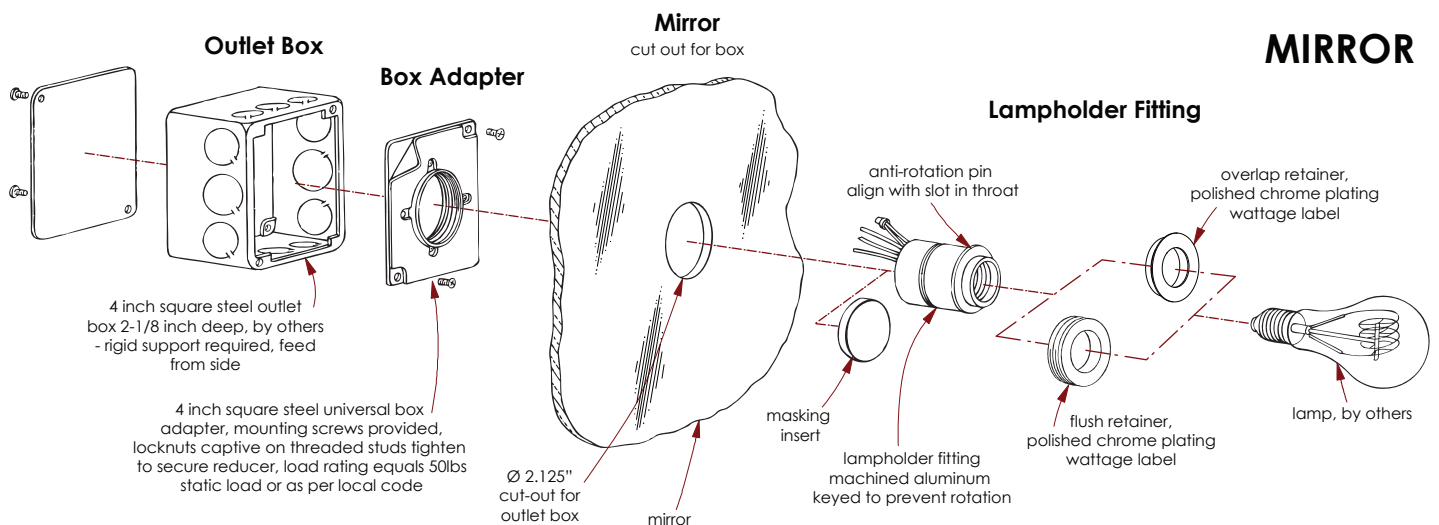

UL LISTED

RECESSED SOCKETS

UL LISTED • DAMP OR DRY LOCATION

RS 1.9

mounting kit

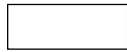

1

cover

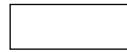

2

finish

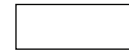

3

wattage label

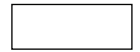

4

DW

drywall

- ▶ screw in hub flush outlet box mounting system
- ▶ rigid support required

AM

architectural millwork

- ▶ screw in hub flush outlet box mounting system
- ▶ rear access required for installation

MR

¼" mirror

- ▶ unique support system enables patterns

Contact factory for:

- concrete kits
- grid/ceiling tile kits
- JA8 compliant lampholder

FD

flush drywall

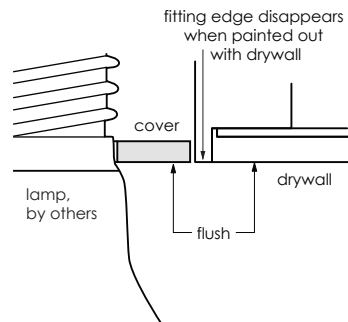

1.95" diameter cover

FM

flush millwork or mirror

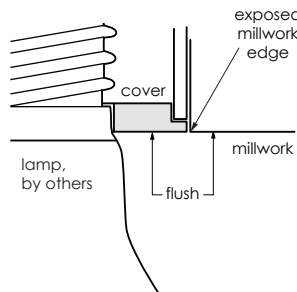

2.1" diameter cover

OM

overlap millwork or mirror

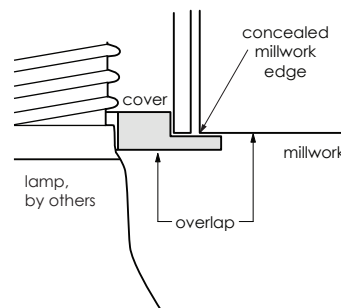

2.25" diameter cover

WT

white low gloss baked enamel

6W

BL

black low gloss baked enamel

9W

BZ

statuary bronze low gloss baked enamel

13W

DB

solid brass dark patina

20W

BB

solid brass burnished natural

40W

PC

polished chrome

60W

XC

custom color baked enamel

CL

custom labels available